

Gampper ARMATUREN

Ein Unternehmen der AFRISO Gruppe



Vario-DP Pressure Independent Radiator Valve



Vario-DP: Pressure Independent Automatic Balance and Control Thermostatic Valve.

The patented dynamic valve insert with capsule control diaphragm, automatically limits and maintains the flow rate of water, independent of pressure fluctuations in the heating system.

Consequently, irrespective of how many other valves are opened or closed in the system, the Vario-DP will always provide the pre-set flow rate to the radiator.



Features:

- No need for Commissioning valves or DPCV's.
- Easy Radiator, tamper proof, flow rate setting.
- Linear flow rate adjustment up to 240 l/h.
- Accurate easy access system balancing, achieved at the radiator.
- Accurate temperature control irrespective of system pressure fluctuations.
- Suitable for flushing of the radiator.
- Full open adjustment for valve purging.
- Valve insert replaceable with special tool.

Pressure Independent capsule concept:

The capsule diaphragm is subjected to inlet pressure internally and outlet pressure externally.

As the differential pressure across the valve increases the capsule expands.

As the differential pressure across the valve decreases the capsule shrinks.

The valve axial length adjusts in accordance to the differential pressure, regulating water flow rate without any further control elements.



Capsule external surface
subject to the outlet pressure

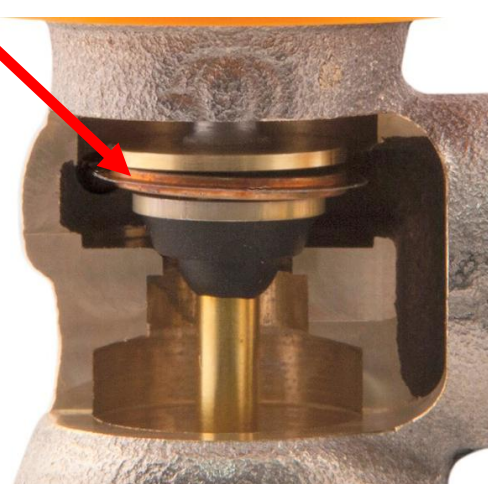

Inlet pressure sensor
connected to capsule
internal cavity.

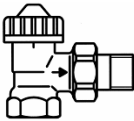
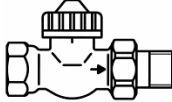
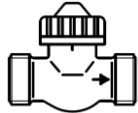
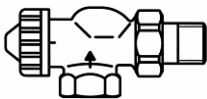
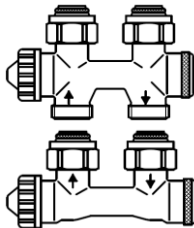
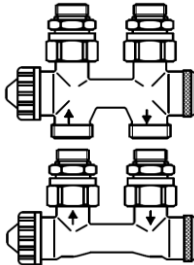

4.5 Vario-DP dynamic thermostatic valve

Construction	Nominal-width	Cv-value	Ref.-No.	
<p>Vario-DP- radiator valve, with dynamic valve insert. The pressure independent valve will automatically set the water flow rate. Pressure Differential Pressure Range 20-50 kPa, Flow rate range 20-240 l/h, adjustable with a presetting key. Valve body made of red brass, nickel-plated, PN 10max. Temperature 110°C, with M 30 x 1,5 mm threaded connection. Valve spindle sealed by two O-rings maintenance free sealing, with assembly cap. Valve insert replaceable without draining off the system under operating pressure with installation device</p>				
Angle	3/8"		161 010.100	
	1/2"		161 020.100	
	3/4"		161 030.100	
Straight	3/8"		161 060.100	
	1/2"		161 070.100	
	3/4"		161 080.100	
Straight BG, with both sides AG without nickelt		1/2"	160 076.100	
<hr/>				
Angle reverse	1/2"		163 020.101	
<hr/>				
<p>Vario-DP- double connection fitting, for radiator with middle connection in two pipe system with a dynamic thermostatic valve insert. The dynamic valve will automatically the set the water flow rate. Working range 20-50 kPa, flow rate 20-240 l/h, adjustable with a presetting key, valve body made of brass, nickel-plated, PN 10max., temperature 110°C, valve spindle sealed by two O-rings for maintenance free sealing, with M 30 x 1,5 mm threaded connection, shut-off valve made of brass, connections on pipe side with 3/4" Euro taper.</p>				
Construction for compact- / towel radiator with 3/4" Euro taper				
Straight	3/4"		221 070.100	
Angle	3/4"		221 020.100	
Construction for compact- / towel radiator with 1/2" female thread				
Straight	1/2"		221 075.100	
Angle	1/2"		221 025.100	
<hr/>				
<p>Valve insert, for thermostatic valve body of</p>				
Insert	3/8" – 3/4"		130 010.201	
<hr/>				
Presetting key			140 110.850	
<hr/>				

Technical specifications – Flow rate and valve setting.

			1K								2K			
Einstellung	1	1,5	2	2,25	2,5	2,75	3	3,25	3,5	3,75	4	4,25	4,5	4,75
I/h	20	30	40	50	60	70	80	90	100	110	120	130	135	140

Einstellung	5	5,25	5,5	5,75	6	6,25	6,5	6,75	7	7,25	7,5	7,75	8	
I/h	150	160	170	180	190	200	220	235	250	260	270	280	290	

Adjustment range: 20-50 kPa

Dimension

Standard-thermostatic-valve body

Angle

Straight

Straight BG

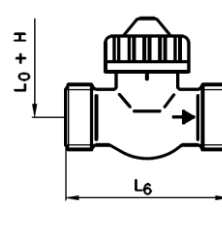
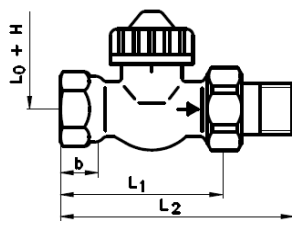
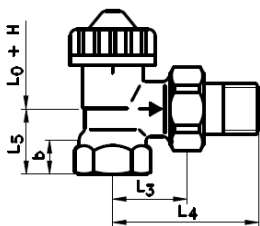

Angle reverse

Angle right or left

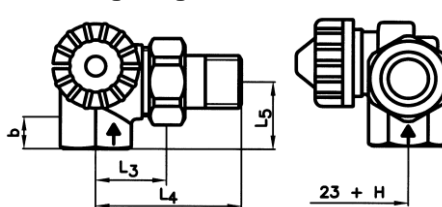
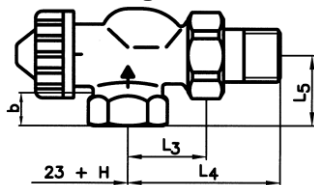

DN	R"	B	L0	L1	L2	L3	L4	L5	L6
10	3/8"	10,1	23	59	85	26	52	25	
15	1/2"	13,2	23	66	95	29	58	26	55
20	3/4"	14,5	23	74	106	34	66	29	
25	1"	16,8	36	90	125	40	75	34	90

Construction for compact- / towel radiator with 3/4" Euro taper

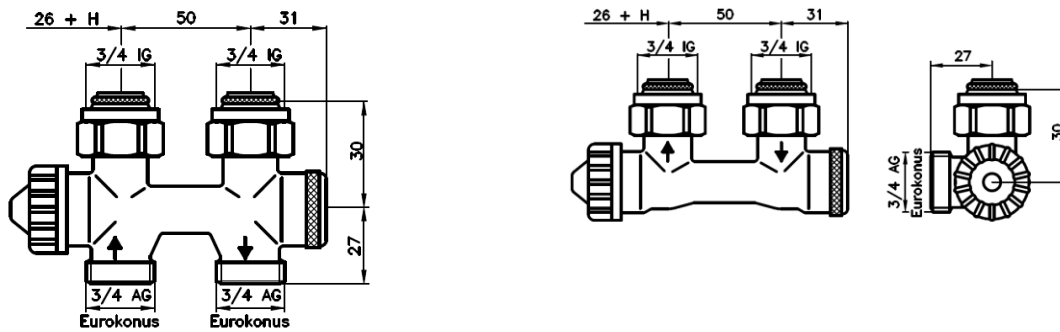

Construction for compact- / towel radiator with 1/2" female thread

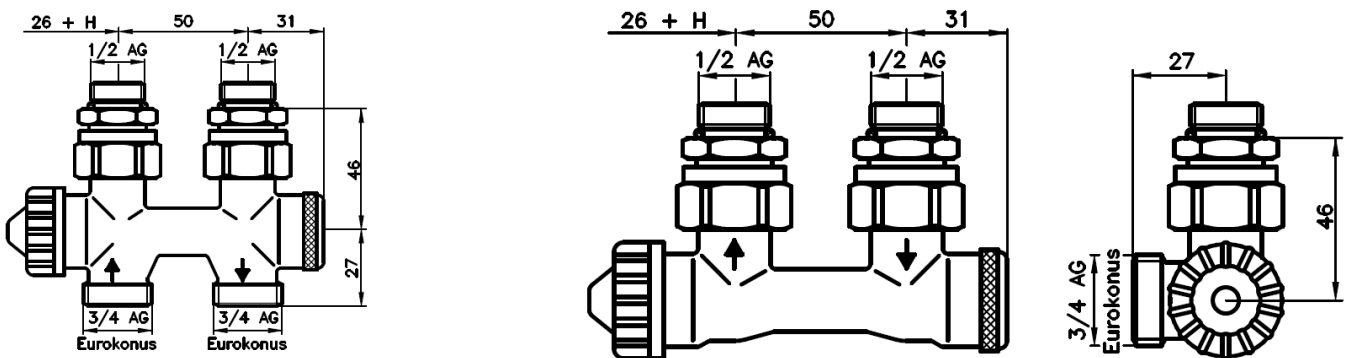

Cover Vario double connection fittings Angle + Straight

Adapter for radiator with R1/2" female thread

273 020.040

